









**DATSUN 620 PICKUP 1972-79**

**REAR LAMPS Cont'd**

**SIDE MARKER LAMP Cont'd**

1 Lens	L 26195-B5501	.3	15.75
2 Ring	L 26191-H1900	.2	6.66
3 Gasket, Mounting	R 26182-H1900		5.69
	L 26194-B5500		2.57
4 Body	L 26199-B5500		2.57
Bulb	NSS		N.A.
	26715-89902		1.17

¶Included in Lamp Assembly

**LICENSE LAMP**

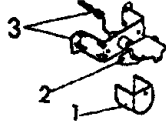

30-152

Lamp Assembly	26510-B5500	.2	10.29
1 Lens	26511-B0400	.2	3.78
2 Body	NSS		N.A.
3 Body, w/Socket	26519-B5000		4.76
Bulb	26716-89911		1.29

¶Included in Lamp Assembly

**REAR BUMPER**

Use Procedure Explanation 27 with the following text.

**(OPTIONAL)**

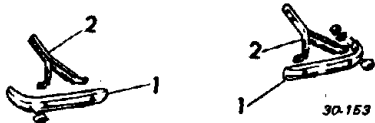

30-153

1 Face Bar	R 85003-B5100	.4	63.39
	L 85004-B5100	.4	63.39
2 Support, Bar	R 85203-B5100	.3	18.98
	L 85204-B5100	.3	18.98

**DATSUN 710 1974-77**

**DATSUN 710 1974-77**

**FRONT BUMPER**

Use Procedure Explanations 1 and 28 with the following text.

R&I Bumper Assembly exc		.5	
Hardtop (to 8-74)		.6	
O/H Includes R&I exc		1.0	
Hardtop (to 8-74)		.9	
Refinish Lower Panel		1.0	

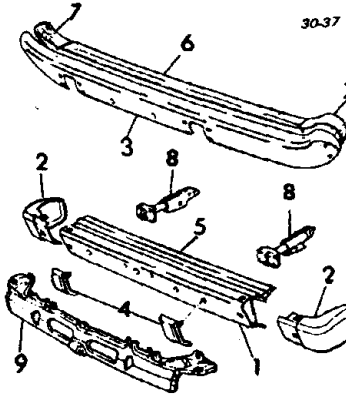

30-37

<b>Face Bar (exc HT To 8-74)</b>			
1 Center	To 7-75 62020-K2400	1.0	160.51
	8-75- 62020-N7100	1.0	106.67
2 Side	To 7-75 R 62030-K2400	.8	66.61
	L 62031-K2400	.8	66.61
	8-75- R 62030-N7100	.8	61.43
	L 62031-N7100	.8	61.43
3 Face Bar (HT)			
To 8-74			
4 Guard	exc R 62651-K2500	.9	185.02
	L 62050-K2400	.3	34.56
	L 62051-K2400	.3	34.56
	HT To 8-74 R 62050-K2501	.3	39.50
	L 62051-K2501	.3	39.50
	All 8-74 To 7-75 R 62050-N6000	.3	49.21
	L 62051-N6000	.3	d46.37
<b>Deflector, Stone</b>			
5 exc	To 7-75 62080-K2401	.7	98.31
	8-75- 62080-N7100	.7	67.61
HT (To 8-74)			
6 Center	62081-K2500	.7	96.22
7 Side	R 62082-K2500		d47.05
	L 62083-K2500		41.60
8 Absorber, Impact	R 62210-N6000	¶.2	154.92
	L 62211-N6000	¶.2	154.92
	¶w/Bumper Assy Rem		
9 Panel, Lower Air	62611-K2430	¶.5	73.46
	¶w/Bumper Assy & Grille Rem		

**GRILLE & PANELS**

Use Procedure Explanations 5 and 28 with the following text.

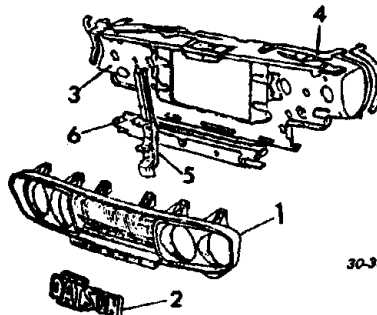

30-38

1 Grille	62310-K2400	.8	219.69
2 Emblem	62810-U5925	.1	9.39
3 Support Assy	62500-N7100	¶ #3.5	191.11
	¶w/Bmpr, Grille, Lamps & Both Fens Rem		
4 Panel, Upper	62511-K0125	¶ #1.5	d37.36
5 Support, Latch	62520-K0100	¶	6.12
6 Crossmember, Lower	74820-K0100	¶ #2.5	52.78
	¶w/Bolted Parts Rem		
	¶Included in Support Assembly		

**FRONT LAMPS**

**HEADLAMP**

R&R Does Not Include Aim Lamps		.4	
--------------------------------	--	----	--

**FRONT LAMPS Cont'd**

**HEADLAMP Cont'd**

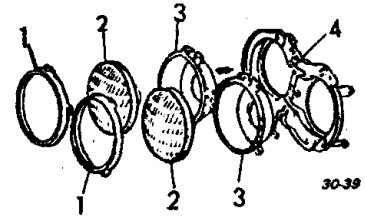

30-39

<b>Lamp Assembly</b>			
exc (Kofko)	R 26010-K2400	¶1.1	64.94
	L 26060-K2400	¶1.1	64.94
HT (Ichiko)	R 26010-U1700	¶1.1	60.70
	L 26060-U2000	¶1.1	60.70
	¶exc w/Grille Rem .3		
1 Ring, Retaining	26023-89904		5.38
2 Sealed Beam			
Outer	26702-89915	¶.2	d4.35
Inner	26701-89910	¶.2	d4.35
	¶Both One Side .3		
3 Body			
Outer	exc R 26016-89900		6.93
	L 26018-89900		6.93
	HT R 26016-21001		8.40
	L 26018-89900		6.93
Inner	exc R 26017-89900		6.74
	L 26019-89900		6.74
	HT R 26702-89925		11.64
	L 26019-89900		6.74
4 Panel, Mounting	NSS		N.A.
	¶Included in Lamp Assembly		

**PARK/SIGNAL LAMP**

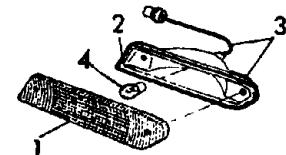

30-40

<b>Lamp Assembly</b>			
To 8-74	R 26120-K2400	.3	30.83
	L 26125-K2400	.3	30.83
	9-74- R 26120-N6000	.3	30.83
	L 26125-N6000	.3	30.83
1 Lens	R 26121-K2400	.2	6.51
	L 26126-K2400	.2	6.51
2 Gasket	R 26123-K2400	.2	3.64
	L 26128-K2400	.2	3.64
3 Housing	NSS		N.A.
4 Bulb	26717-89970		2.39
	¶Included in Lamp Assembly		

**SIDE MARKER LAMP**

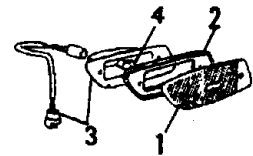

30-41

<b>Lamp Assembly</b>			
To 8-74	R 26180-K2400	.3	31.95
	L 26185-K2400	.3	31.95
9-74-	R 26180-N7100	.3	29.31
	L 26185-N6000	.3	29.31
1 Lens	R 26181-K2400	.2	5.69
	L 26186-K2400	.2	5.69
2 Gasket, Lens	R 26183-K2400	.2	3.04
	L 26188-K2400	.2	3.04
3 Housing	NSS		N.A.
4 Bulb	26715-89902		1.17
	¶Included in Lamp Assembly		

**COOLING**

Use Procedure Explanations 5 and 28 with the following text.

R&R Radiator Hose w/Radiator Removed		.1	
One			
All		.2	
R&R Fan, Pulley And/or Clutch			
w/Radiator Removed		.2	